



Part no.: 50122106
PRK5/4-200-M8.3
Polarized retro-reflective photoelectric sensor



Figure can vary

Contents

- Technical data
- Reflectors & reflective tapes
- Dimensioned drawings
- Electrical connection
- Diagrams
- Operation and display
- Part number code
- Accessories
- Notes

Technical data

Basic data	
Series	5
Operating principle	Reflection principle

Optical data	
Operating range	Guaranteed operating range
Operating range	0.02 ... 4.5 m, With reflector TK(S) 100x100
Operating range limit	Typical operating range
Operating range limit	0.02 ... 6 m, With reflector TK(S) 100x100
Light source	LED, Red
LED light wavelength	620 nm
Transmitted-signal shape	Pulsed
LED protection class	Exempt group (in acc. with EN 62471)

Electrical data	
Protective circuit	Short circuit protected Polarity reversal protection

Performance data	
Supply voltage	10 ... 30 V, DC, Incl. residual ripple
Residual ripple	0 ... 15 %, From U_B
Open-circuit current	0 ... 20 mA

Outputs	
Number of digital switching outputs	1 Piece(s)

Switching outputs	
Voltage type	DC
Switching current, max.	100 mA
Switching voltage	High: $\geq(U_B-2V)$

Switching output 1	
Assignment	Connection 1, pin 4
Switching element	Transistor, PNP
Switching principle	Light switching

Timing	
Switching frequency	500 Hz
Response time	1 ms
Readiness delay	300 ms

Connection	
-------------------	--

Connection 1

Type of connection	Cable with connector
Function	Voltage supply Signal OUT
Cable length	200 mm
Sheathing material	PUR
Cable color	Black
Wire cross section	0.2 mm ²
Thread size	M8
Type	Male
Material	Plastic
No. of pins	3 -pin
Design	Axial

Mechanical data

Dimension (W x H x L)	14 mm x 32.5 mm x 20.2 mm
Housing material	Plastic, ABS
Lens cover material	Plastic
Net weight	40 g
Housing color	Black Red

Operation and display

Type of display	LED
Number of LEDs	2 Piece(s)

Environmental data

Ambient temperature, operation	-40 ... 60 °C
Ambient temperature, storage	-40 ... 70 °C

Certifications

Degree of protection	IP 67
Protection class	III
Certifications	c UL US
Standards applied	IEC 60947-5-2

Classification

eCl@ss 8.0	27270902
eCl@ss 9.0	27270902
ETIM 5.0	EC002717

Reflectors & reflective tapes

	Part no.	Designation	Operating range/ Operating range limit	Description
	50108300	REF 4-A-50x50	0.08 ... 1.4 m 0.08 ... 2 m	Design: Rectangular Reflective surface: 50 mm x 50 mm Material: Plastic Chemical designation of the material: PMMA Fastening: Self-adhesive
	50003192	TK 100x100	0.02 ... 4.5 m 0.02 ... 6 m	Design: Rectangular Reflective surface: 96 mm x 96 mm Triple reflector size: 4 mm Material: Plastic Base material: Plastic Chemical designation of the material: PMMA8N Fastening: Adhesive
	50003189	TK 30x50	0.03 ... 1.9 m 0.03 ... 2.5 m	Design: Rectangular Reflective surface: 29 mm x 45 mm Triple reflector size: 4 mm Material: Plastic Base material: Plastic Chemical designation of the material: PMMA8N Fastening: Adhesive
	50024127	TK 82.2	0.05 ... 3.6 m 0.05 ... 4.5 m	Design: Round Triple reflector size: 4 mm Reflection surface diameter: 79 mm Material: Plastic Base material: Plastic Chemical designation of the material: PMMA8N Fastening: Through-hole mounting, Adhesive
	50022816	TKS 100X100	0.02 ... 4.5 m 0.02 ... 6 m	Design: Rectangular Reflective surface: 96 mm x 96 mm Triple reflector size: 4 mm Material: Plastic Base material: Plastic Chemical designation of the material: PMMA8N Fastening: Through-hole mounting, Adhesive
	50081283	TKS 20X40	0.04 ... 1.6 m 0.04 ... 2.2 m	Design: Rectangular Reflective surface: 16 mm x 38 mm Triple reflector size: 2.3 mm Material: Plastic Base material: Plastic Chemical designation of the material: PMMA8N Fastening: Through-hole mounting, Adhesive
	50023525	TKS 30X50	0.03 ... 1.9 m 0.03 ... 2.5 m	Design: Rectangular Reflective surface: 27 mm x 44 mm Triple reflector size: 3 mm Material: Plastic Base material: Plastic Chemical designation of the material: PMMA8N Fastening: Through-hole mounting, Adhesive
	50040820	TKS 40X60	0.02 ... 3 m 0.02 ... 4 m	Design: Rectangular Reflective surface: 37 mm x 56 mm Triple reflector size: 4 mm Material: Plastic Base material: Plastic Chemical designation of the material: PMMA8N Fastening: Through-hole mounting, Adhesive

Dimensioned drawings

All dimensions in millimeters

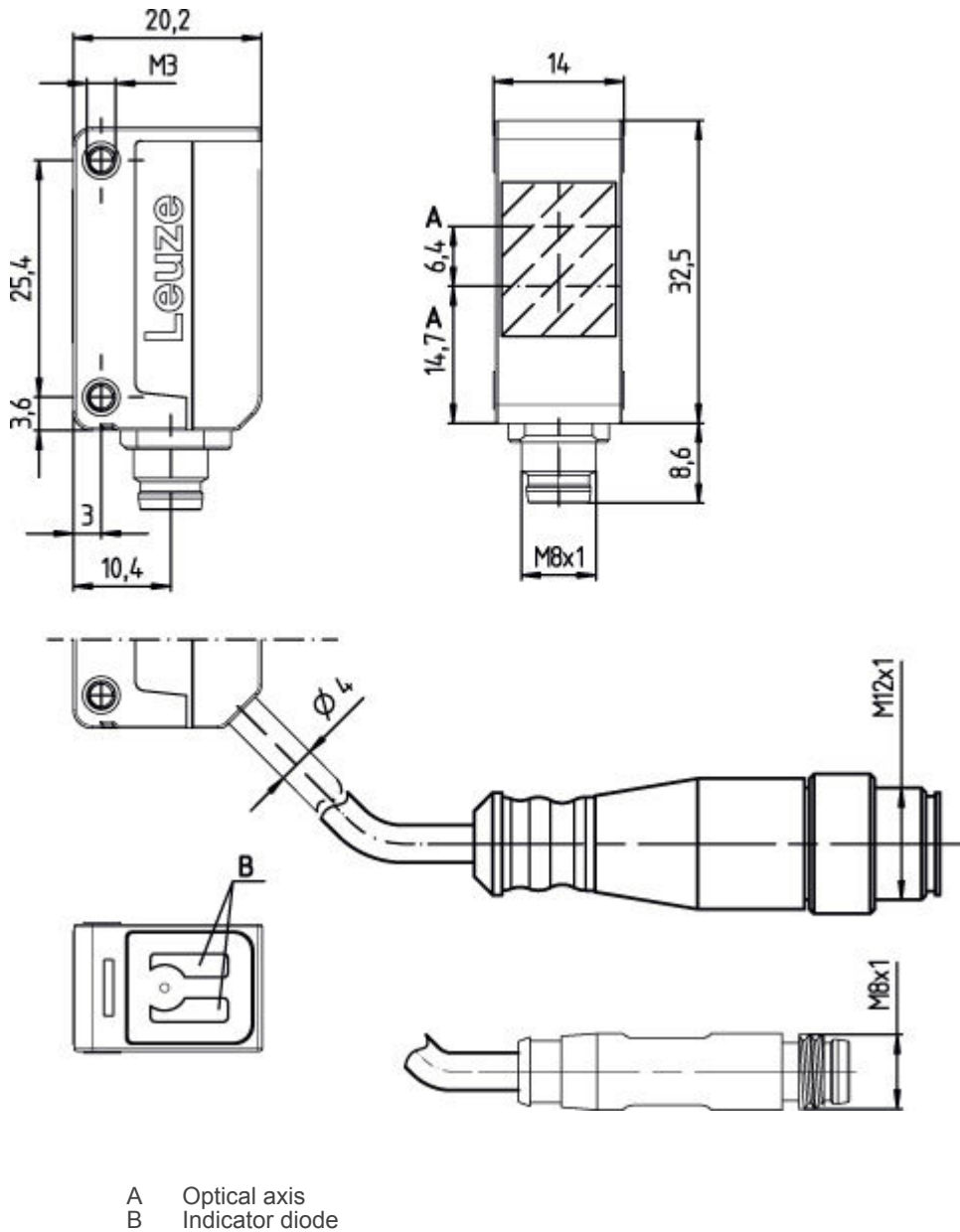

Electrical connection

Connection 1	
Type of connection	Cable with connector
Function	Voltage supply Signal OUT
Cable length	200 mm
Sheathing material	PUR
Cable color	Black
Wire cross section	0.2 mm ²
Thread size	M8
Type	Male
Material	Plastic

Part no.: 50122106 – PRK5/4-200-M8.3 – Polarized retro-reflective photoelectric

Connection 1	
No. of pins	3 -pin
Encoding	
Design	Axial

Pin	Pin assignment
1	V+
3	GND
4	OUT 1

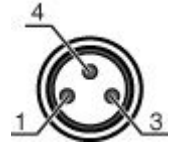

Diagrams

Typ. response behavior (TKS100x100)

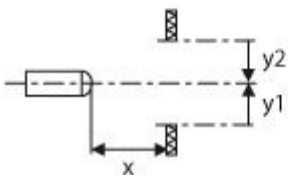
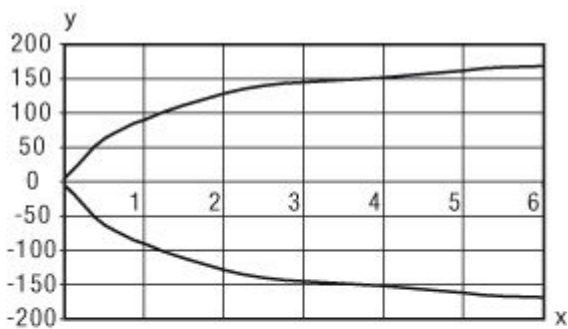

x Distance [m]
y Misalignment [mm]

Typ. function reserve

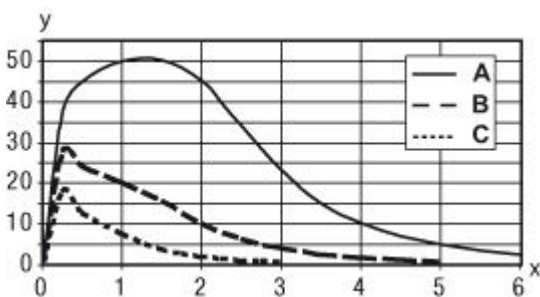

x Distance [m]
y Function reserve
A TKS 100x100

B TKS 40x60
C TKS 20x40

Operation and display

LEDs

LED	Display	Meaning
1	Yellow, continuous light	Light path free
	Yellow, flashing	No function reserve
2	Green, continuous light	Operational readiness









Part number code

Part designation: **AAA5d.EE/ ff-GG-hh-l**







AAA5	Operating principle / construction: HT5: diffuse reflection sensor with background suppression LS5: throughbeam photoelectric sensor transmitter LE5: throughbeam photoelectric sensor receiver ET5: energetic diffuse reflection sensor FT5: diffuse reflection sensor with fading PRK5: retro-reflective photoelectric sensor with polarization filter
d	Light type: n/a: red light I: infrared light
EE	Equipment: 1: adjustable range M: for semi-transparent objects H: for the detection of transparent films X: reinforced fading 3: teach-in via button R: combination product for reflector DTKS 30x50
ff	Switching output / function / OUT1OUT2 (OUT1 = pin 4, OUT2 = pin 2): 2: NPN transistor output, light switching N: NPN transistor output, dark switching 4: PNP transistor output, light switching P: PNP transistor output, dark switching X: pin not used 9: deactivation input (deactivation with high signal) D: deactivation input (deactivation with low signal)
GG	Design: P1: narrow light beam
hh	Electrical connection: n/a: cable, PVC, standard length 2000 mm, 4-wire M8: M8 connector, 4-pin (plug) M8.3: M8 connector, 3-pin (plug) 200-M8: cable, PVC, length 200 mm with M8 connector, 4-pin, axial (plug) 200-M8.3: cable, PVC, length 200 mm with M8 connector, 3-pin, axial (plug) 200-M12: cable, PVC, length 200 mm with M12 connector, 4-pin, axial (plug) M8.1: Snap-in, M8 connector, 4-pin (plug)
l	Configuration: P1: configuration for label detection

Accessories

Connection technology - Connection cables

	Part no.	Designation	Article	Description
	50130842	KD U-M8-3A-P1-020	Connection cable	Connection 1: Connector, M8, Axial, Female, 3 -pin Connection 2: Open end Shielded: No Cable length: 2,000 mm Sheathing material: PUR
	50130844	KD U-M8-3A-P1-050	Connection cable	Connection 1: Connector, M8, Axial, Female, 3 -pin Connection 2: Open end Shielded: No Cable length: 5,000 mm Sheathing material: PUR
	50130845	KD U-M8-3A-P1-100	Connection cable	Connection 1: Connector, M8, Axial, Female, 3 -pin Connection 2: Open end Shielded: No Cable length: 10,000 mm Sheathing material: PUR
	50130846	KD U-M8-3A-P1-150	Connection cable	Connection 1: Connector, M8, Axial, Female, 3 -pin Connection 2: Open end Shielded: No Cable length: 15,000 mm Sheathing material: PUR
	50130847	KD U-M8-3A-P1-200	Connection cable	Connection 1: Connector, M8, Axial, Female, 3 -pin Connection 2: Open end Shielded: No Cable length: 20,000 mm Sheathing material: PUR
	50130837	KD U-M8-3A-V1-020	Connection cable	Connection 1: Connector, M8, Axial, Female, 3 -pin Connection 2: Open end Shielded: No Cable length: 2,000 mm Sheathing material: PVC
	50130832	KD U-M8-3A-V1-050	Connection cable	Connection 1: Connector, M8, Axial, Female, 3 -pin Connection 2: Open end Shielded: No Cable length: 5,000 mm Sheathing material: PVC
	50130839	KD U-M8-3A-V1-100	Connection cable	Connection 1: Connector, M8, Axial, Female, 3 -pin Connection 2: Open end Shielded: No Cable length: 10,000 mm Sheathing material: PVC
	50130840	KD U-M8-3A-V1-150	Connection cable	Connection 1: Connector, M8, Axial, Female, 3 -pin Connection 2: Open end Shielded: No Cable length: 15,000 mm Sheathing material: PVC



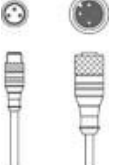

Part no.: 50122106 – PRK5/4-200-M8.3 – Polarized retro-reflective photoelectric

	Part no.	Designation	Article	Description
	50130841	KD U-M8-3A-V1-200	Connection cable	Connection 1: Connector, M8, Axial, Female, 3 -pin Connection 2: Open end Shielded: No Cable length: 20,000 mm Sheathing material: PVC
	50130865	KD U-M8-3W-P1-020	Connection cable	Connection 1: Connector, M8, Angled, Female, 3 -pin Connection 2: Open end Shielded: No Cable length: 2,000 mm Sheathing material: PUR
	50130867	KD U-M8-3W-P1-050	Connection cable	Connection 1: Connector, M8, Angled, Female, 3 -pin Connection 2: Open end Shielded: No Cable length: 5,000 mm Sheathing material: PUR
	50130868	KD U-M8-3W-P1-100	Connection cable	Connection 1: Connector, M8, Angled, Female, 3 -pin Connection 2: Open end Shielded: No Cable length: 10,000 mm Sheathing material: PUR
	50130860	KD U-M8-3W-V1-020	Connection cable	Connection 1: Connector, M8, Angled, Female, 3 -pin Connection 2: Open end Shielded: No Cable length: 2,000 mm Sheathing material: PVC
	50130862	KD U-M8-3W-V1-050	Connection cable	Connection 1: Connector, M8, Angled, Female, 3 -pin Connection 2: Open end Shielded: No Cable length: 5,000 mm Sheathing material: PVC
	50130863	KD U-M8-3W-V1-100	Connection cable	Connection 1: Connector, M8, Angled, Female, 3 -pin Connection 2: Open end Shielded: No Cable length: 10,000 mm Sheathing material: PVC



Connection technology - Interconnection cables

	Part no.	Designation	Article	Description
	50130931	KDS U-M8-3A-M12-3A-P1-020	Interconnection cable	Connection 1: Connector, M8, Axial, Female, 3 -pin Connection 2: Connector, M12, Axial, Male, A-coded, 3 -pin Shielded: No Cable length: 2,000 mm Sheathing material: PUR
	50130932	KDS U-M8-3A-M12-3A-P1-050	Interconnection cable	Connection 1: Connector, M8, Axial, Female, 3 -pin Connection 2: Connector, M12, Axial, Male, A-coded, 3 -pin Shielded: No Cable length: 5,000 mm Sheathing material: PUR



Part no.: 50122106 – PRK5/4-200-M8.3 – Polarized retro-reflective photoelectric

	Part no.	Designation	Article	Description
	50130905	KDS U-M8-3A-M8-3A-P1-020	Interconnection cable	Connection 1: Connector, M8, Axial, Female, 3 -pin Connection 2: Connector, M8, Axial, Male, 3 -pin Shielded: No Cable length: 2,000 mm Sheathing material: PUR
	50130907	KDS U-M8-3A-M8-3A-P1-050	Interconnection cable	Connection 1: Connector, M8, Axial, Female, 3 -pin Connection 2: Connector, M8, Axial, Male, 3 -pin Shielded: No Cable length: 5,000 mm Sheathing material: PUR
	50130900	KDS U-M8-3A-M8-3A-V1-020	Interconnection cable	Connection 1: Connector, M8, Axial, Female, 3 -pin Connection 2: Connector, M8, Axial, Male, 3 -pin Shielded: No Cable length: 2,000 mm Sheathing material: PVC
	50130920	KDS U-M8-3W-M8-3A-P1-020	Interconnection cable	Connection 1: Connector, M8, Angled, Female, 3 -pin Connection 2: Connector, M8, Axial, Male, 3 -pin Shielded: No Cable length: 2,000 mm Sheathing material: PUR





Mounting technology - Mounting brackets

	Part no.	Designation	Article	Description
	50118542	BT 200M.5	Mounting bracket	Design of mounting device: Angle, L-shape Fastening, at system: Through-hole mounting Mounting bracket, at device: Screw type Type of mounting device: Adjustable Material: Stainless steel
	50124651	BT 205M-10SET	Mounting device set	Contains: 10x Design of mounting device: Angle, L-shape Fastening, at system: Through-hole mounting Mounting bracket, at device: Screw type Type of mounting device: Rigid Material: Metal

Mounting technology - Rod mounts

	Part no.	Designation	Article	Description
	50117830	BTP 200M-D10	Mounting system	Design of mounting device: Protection hood Fastening, at system: For 10 mm rod Mounting bracket, at device: Screw type Type of mounting device: Clampable, Adjustable, Turning, 360° Material: Metal
	50117829	BTP 200M-D12	Mounting system	Design of mounting device: Protection hood Fastening, at system: For 12 mm rod Mounting bracket, at device: Screw type Type of mounting device: Clampable, Adjustable, Turning, 360° Material: Metal



Part no.: 50122106 – PRK5/4-200-M8.3 – Polarized retro-reflective photoelectric

	Part no.	Designation	Article	Description
	50117828	BTP 200M-D14	Mounting system	Design of mounting device: Protection hood Fastening, at system: For 14 mm rod Mounting bracket, at device: Screw type Type of mounting device: Clampable, Adjustable, Turning, 360° Material: Metal
	50117256	BTU 200M-D10	Mounting system	Contains: 2x M3 x 18 screw, 2x position washers Design of mounting device: Mounting system Fastening, at system: For 10 mm rod, Sheet-metal mounting Mounting bracket, at device: Screw type Type of mounting device: Clampable, Adjustable, Turning, 360° Material: Metal
	50117255	BTU 200M-D12	Mounting system	Contains: 2x M3 x 18 screw, 2x position washers Design of mounting device: Mounting system Fastening, at system: For 12 mm rod, Sheet-metal mounting Mounting bracket, at device: Screw type Type of mounting device: Clampable, Adjustable, Turning, 360° Material: Metal
	50117254	BTU 200M-D14	Mounting system	Contains: 2x M3 x 18 screw, 2x position washers Design of mounting device: Mounting system Fastening, at system: For 14 mm rod, Sheet-metal mounting Mounting bracket, at device: Screw type Type of mounting device: Clampable, Adjustable, Turning, 360° Material: Metal

Standard reflectors

	Part no.	Designation	Article	Description
	50134985	MTKS 20x30.1	Reflector	Design: Rectangular Reflective surface: 18.5 mm x 28.5 mm Triple reflector size: 1 mm Material: Plastic Base material: Plastic Chemical designation of the material: PMMA Fastening: Through-hole mounting, Adhesive
	50003192	TK 100x100	Reflector	Design: Rectangular Reflective surface: 96 mm x 96 mm Triple reflector size: 4 mm Material: Plastic Base material: Plastic Chemical designation of the material: PMMA8N Fastening: Adhesive
	50003189	TK 30x50	Reflector	Design: Rectangular Reflective surface: 29 mm x 45 mm Triple reflector size: 4 mm Material: Plastic Base material: Plastic Chemical designation of the material: PMMA8N Fastening: Adhesive
	50024127	TK 82.2	Reflector	Design: Round Triple reflector size: 4 mm Reflection surface diameter: 79 mm Material: Plastic Base material: Plastic Chemical designation of the material: PMMA8N Fastening: Through-hole mounting, Adhesive
	50022816	TKS 100X100	Reflector	Design: Rectangular Reflective surface: 96 mm x 96 mm Triple reflector size: 4 mm Material: Plastic Base material: Plastic Chemical designation of the material: PMMA8N Fastening: Through-hole mounting, Adhesive

Part no.: 50122106 – PRK5/4-200-M8.3 – Polarized retro-reflective photoelectric

	Part no.	Designation	Article	Description
	50081283	TKS 20X40	Reflector	Design: Rectangular Reflective surface: 16 mm x 38 mm Triple reflector size: 2.3 mm Material: Plastic Base material: Plastic Chemical designation of the material: PMMA8N Fastening: Through-hole mounting, Adhesive
	50023525	TKS 30X50	Reflector	Design: Rectangular Reflective surface: 27 mm x 44 mm Triple reflector size: 3 mm Material: Plastic Base material: Plastic Chemical designation of the material: PMMA8N Fastening: Through-hole mounting, Adhesive
	50040820	TKS 40X60	Reflector	Design: Rectangular Reflective surface: 37 mm x 56 mm Triple reflector size: 4 mm Material: Plastic Base material: Plastic Chemical designation of the material: PMMA8N Fastening: Through-hole mounting, Adhesive

Reflective tapes for standard applications

	Part no.	Designation	Article	Description
	50108300	REF 4-A-50x50	Reflective tape	Design: Rectangular Reflective surface: 50 mm x 50 mm Material: Plastic Chemical designation of the material: PMMA Fastening: Self-adhesive

Notes

Observe intended use!

- This product is not a safety sensor and is not intended as personnel protection.
- The product may only be put into operation by competent persons.
- Only use the product in accordance with its intended use.

For UL applications:

- Only for use in "class 2" circuits
- These proximity switches shall be used with UL Listed Cable assemblies rated 30V, 0.5A min, in the field installation, or equivalent (categories: CYJV/CYJV7 or PVVA/PVVA7)

- Sum of the output currents for both outputs, 50 mA for ambient temperatures > 40 °C